

Pulsar Pro – Online Installation Guide

support.wallbox.com/en/knowledge-base/pulsarpro-online-ig

19 June 2023

1. Technical Specifications

General Specifications

Charging Mode (IEC 61851-1)	Mode 3
Dimensions without cable	198x201x99 mm (without cable)
Weight without cable	1.3 kg (without cable)
Operating Temperature	-30 °C to 50 °C
Storage Temperature	-40 °C to 70 °C
Environmental Ratings	IP55, IK10 (High resistance)
Installation location	Indoor and outdoor use
Mounting Method	Stationary equipment is mounted on the wall. Floor mounting with appropriate Wallbox accessories.
Intended for use	Equipment intended for use by ordinary persons.
Location accesses	Equipment for locations with non-restricted access and restricted access.
Standards	CE, UKCA, EAC and RCM Mark. IEC 61851-1, IEC 61851-21-2, IEC 62196, BS 7671, IEC 60364. RED Directive 2014/53/EU and RoHS Directive 2011/65/EU

*Compliant with UK regulations on smart charging

Electrical Specifications

Charging Power	7,4 kW (1P)	11 kW (3P)*	22 kW (3P)
Rated Voltage AC \pm 10%	230 V	400 V	400 V
Rated Current	32A	16A	32A
*22kW charger limited to 11kW during installation			
Configurable Current	From 6A to rated current		
Rated Frequency	50 Hz / 60 Hz		
Rated diversity factor (RDF)	1		
Rated insulation voltage	1430 Vrms		
Rated diversity factor	4000 V		
Rated impulse withstand voltage	CAT III		
Overvoltage Category	DC 6mA		
External RCCB required pre-local regulations	Type A or Type B		
Protection against electric shocks	Class I		
Cable Section	Up to 13 mm ²		
EV supply equipment connection	AEVCS permanently connected to the AC mains supply network		

2. Safety Warnings

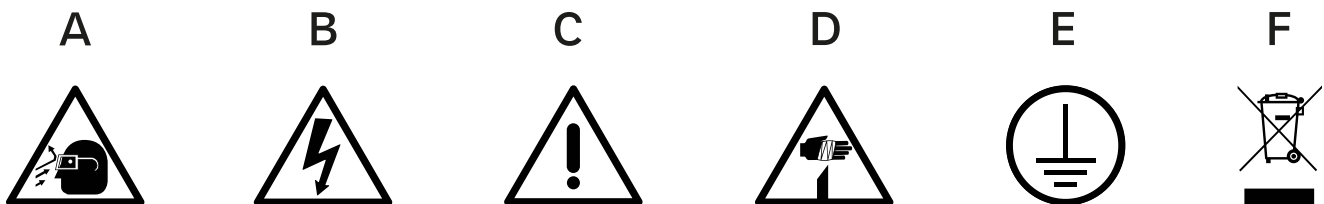

- Flying debris, risk of eye injury
- Risk of electric shock.
Disconnect and wait 10 mins
- Caution
- Sharp element, risk of injurious cuts
- Ground earth connection required

- Special waste treatment

3. Tools and Mounting Parts

Required tools

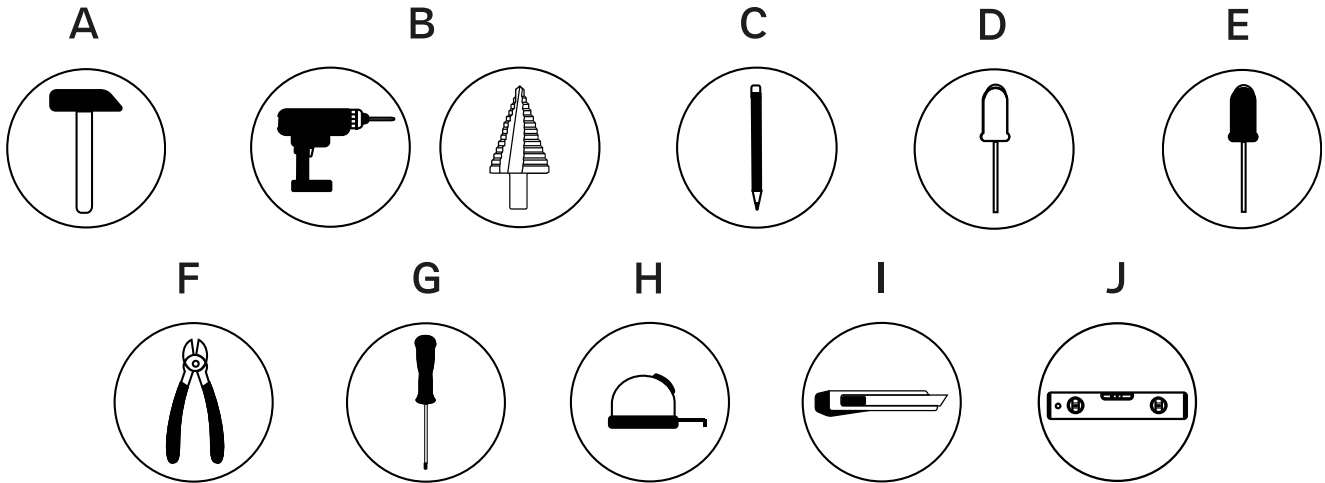

- Hammer
- Step drill bit 32mm and bit 8mm
- Pencil
- Flat Screwdriver
- Phillips Screwdriver
- Cutting Pliers
- Torx T20 and T15
- Measuring Tape
- Utility Knife
- Spirit Level

Included mounting parts

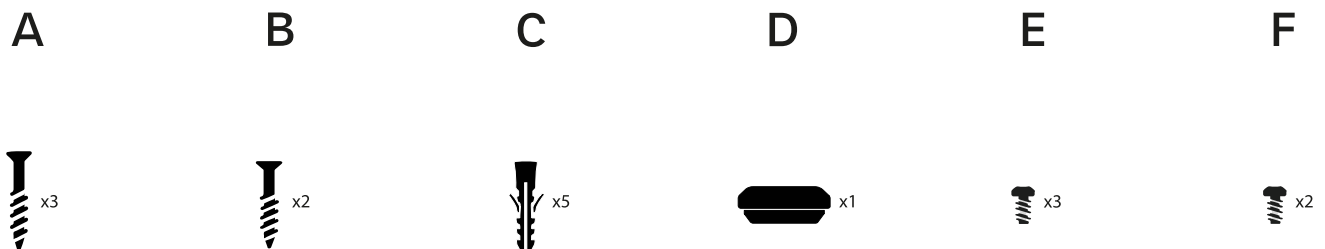

- Phillips Screws $\varnothing 6 \times 50$ mm
- Phillips Screws $\varnothing 5 \times 40$ mm
- Wall Anchors $\varnothing 8 \times 40$ mm

- M32 Grommet
- Torx Screws T20 4 x 10 mm
- Torx Screws T15 \varnothing 3.5 x 8 mm

4. Preparing the Charger

Remove the two corner screws and carefully lift the cover. Then, carefully detach the ribbon cable to set the cover aside.

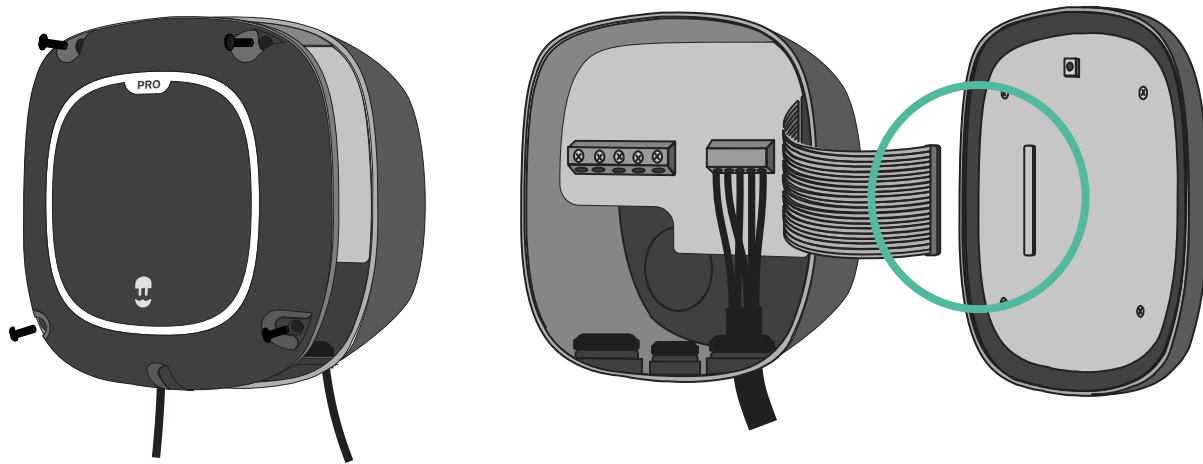

! Before proceeding with the installation, power off all the connections.

5. Installing the Wall Plate

Remove the tape from the wall plate to detach it from the charger. Then, place it straight and mark three holes with a pencil. Now drill with an appropriate-sized bit and place the wall plate in alignment with the holes.

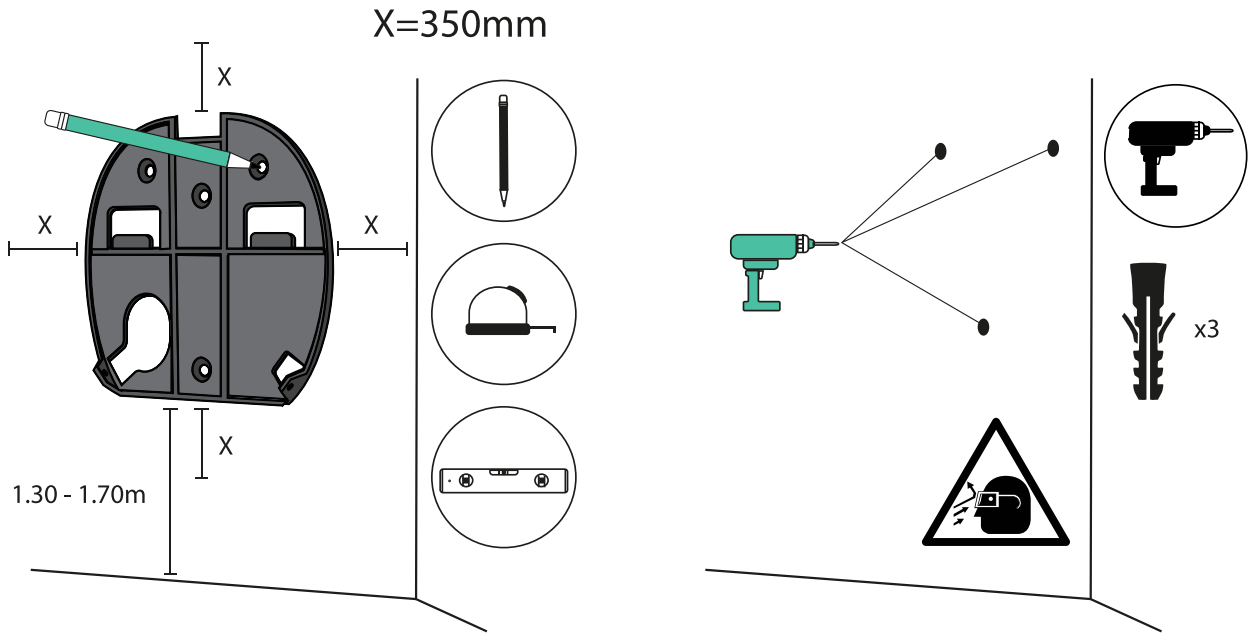

i If you are mounting your charger on a solid wall, use the wall anchors provided with your charger.

Fix the wall plate to the wall, ensuring not to over-tighten the screws.

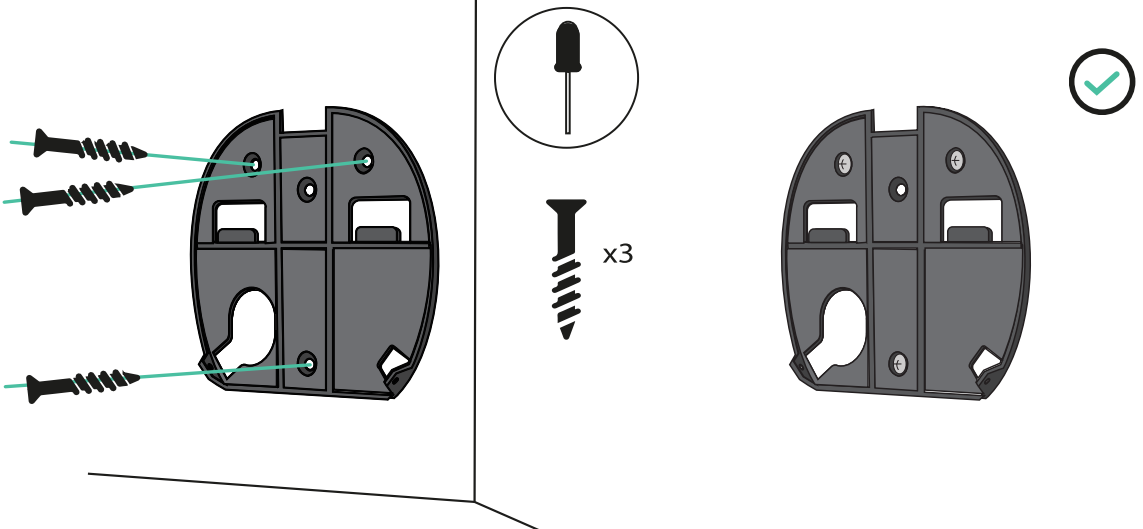

i If case power supply wiring comes from the wall, ensure to place the wires through the wall plate hole before fixing the wall plate.

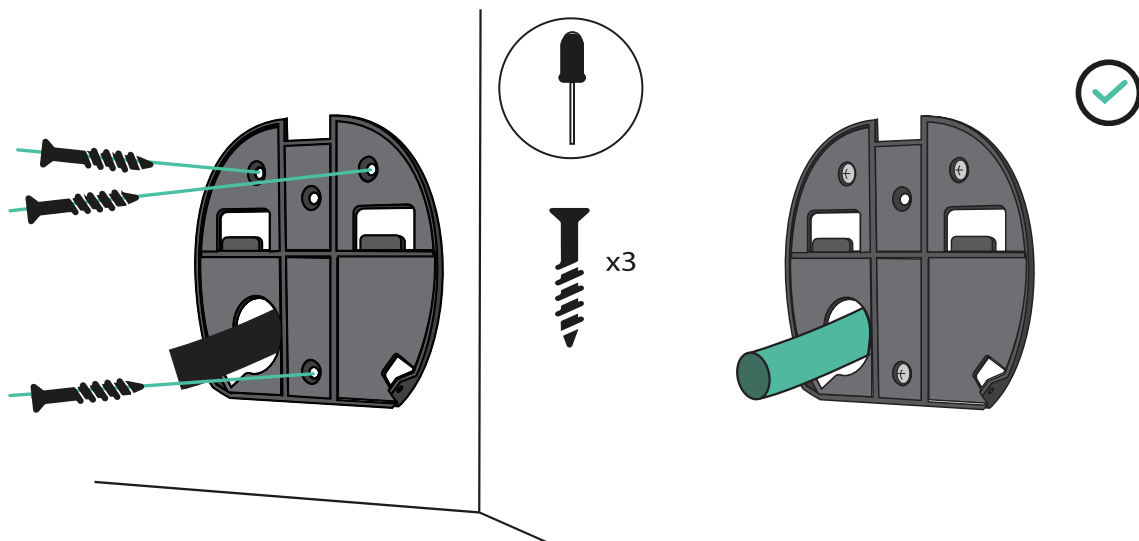

6. Lower Connection

! Both lower and rear connections are possible when installing Pulsar Pro. If you intend to install the product by using the bottom hole, pay attention to the instructions below. For the rear connection, go to section 7.

Lift your charger and hang it from the top of the wall plate. Secure the charger to the wall plate with the appropriate screws, avoiding over-tighten.

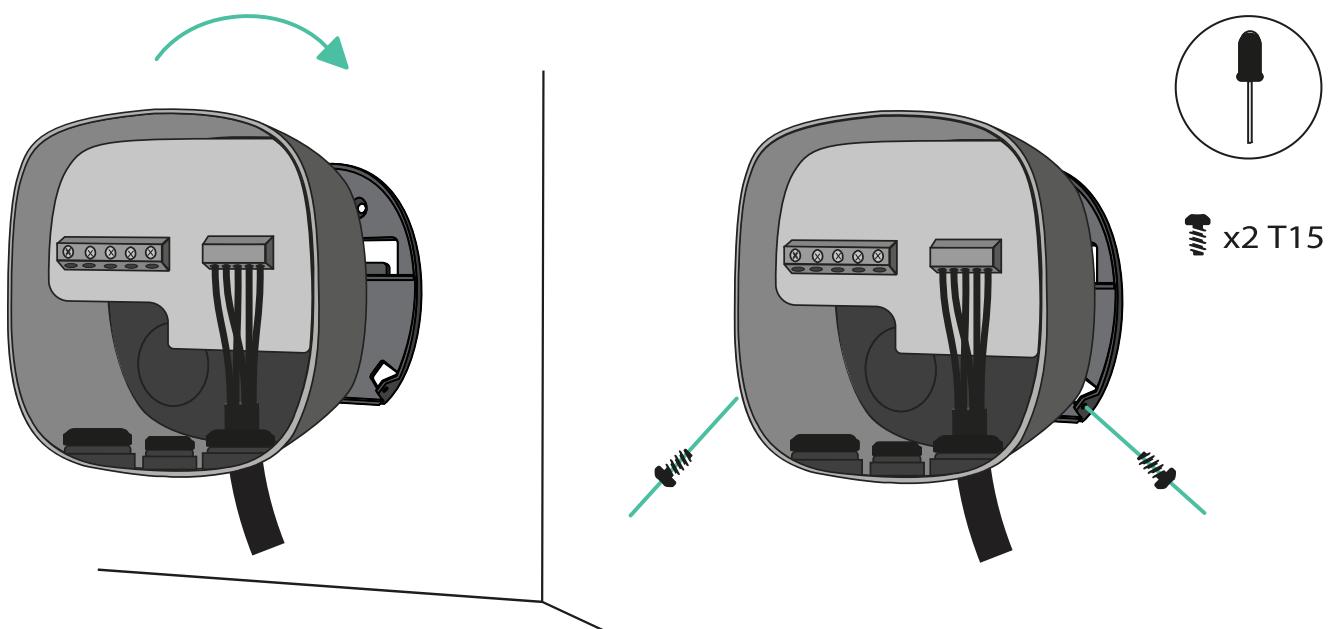

Make an incision on the grommet and insert the power supply cable.

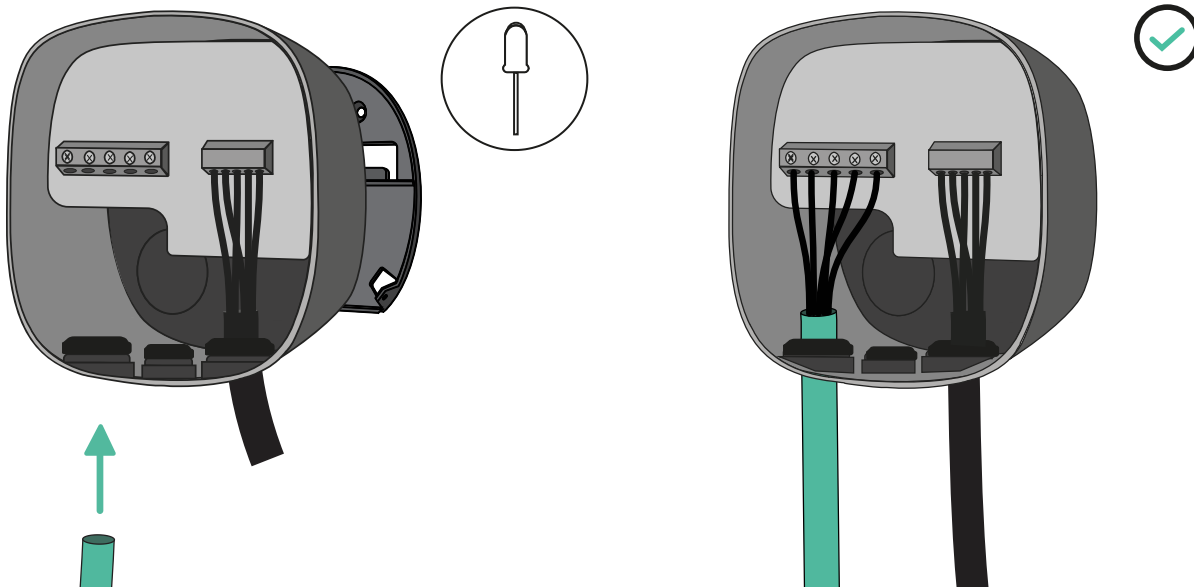

7. Rear Connection

Make a hole on the back of the charger, using a Step drill bit 32mm. Then, make an incision in the grommet and insert the power supply cable.

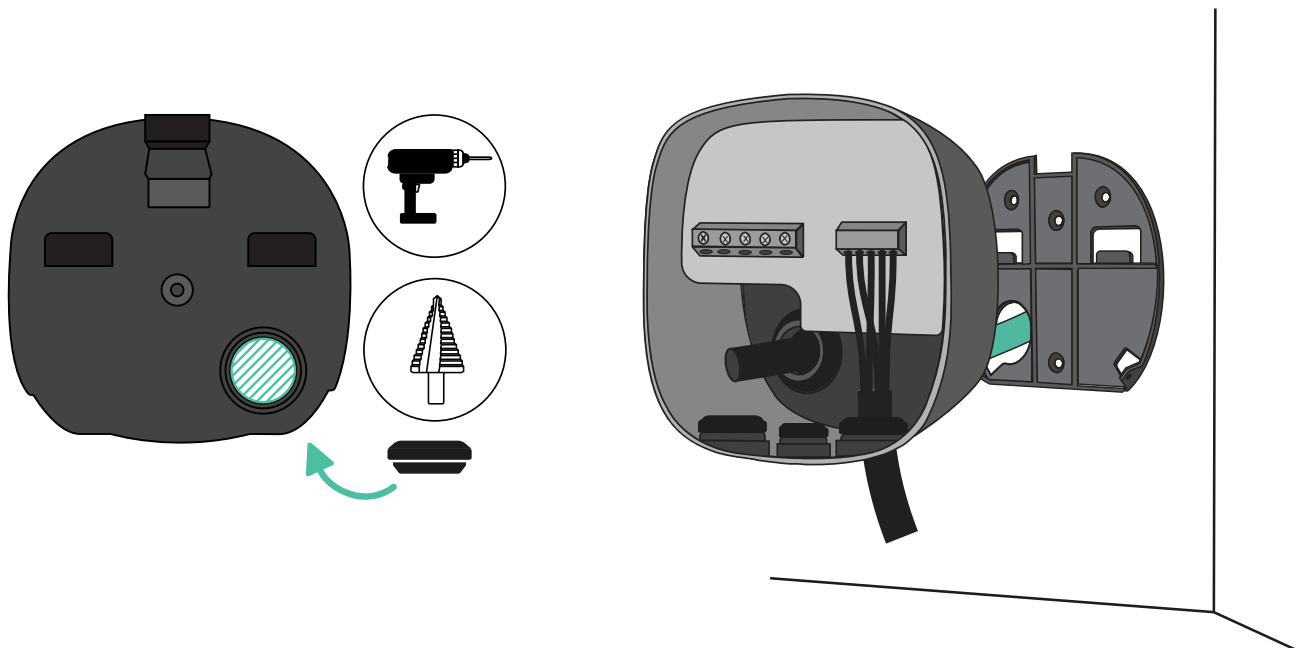

Fix your charger to the wall plate and then fix it using the appropriate screws.

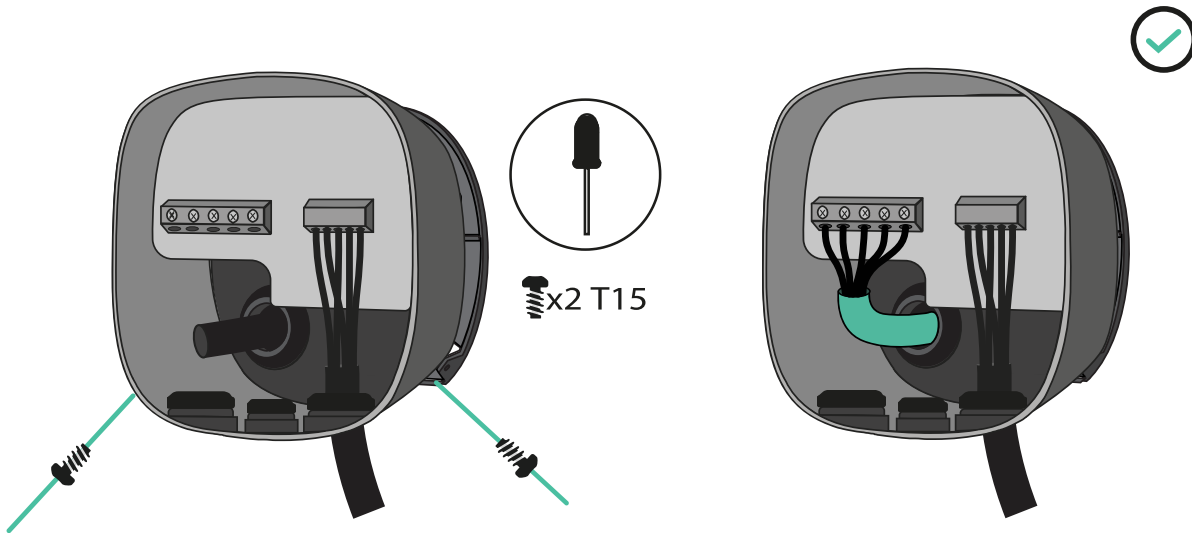

! Visit the EMS Installation Guide for discovering which features are supported by Pulsar Pro.

8. Electrical Wiring

Single Phase Version

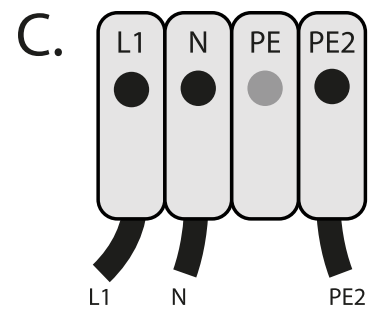
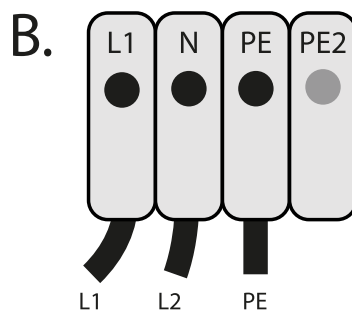
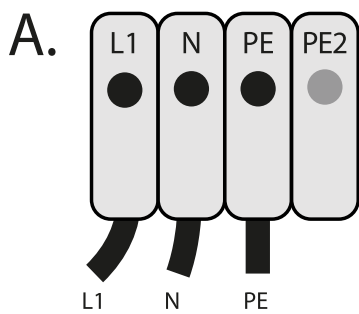

- Single Phase Set-up
- Bi-phase No Neutral
- Single Phase PME

! (UK only) can be connected to the PME supply according to BS7671:2018-
amd1:2020 722.411.4.1

Three Phase Version

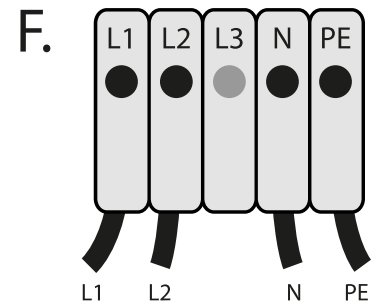
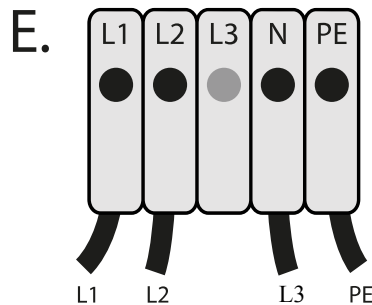
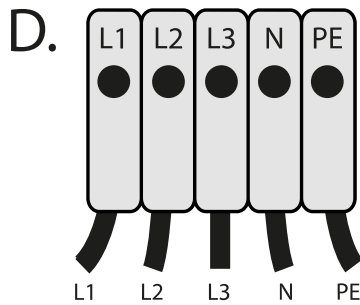



D. Three Phase Set-up

E. Three-phase No Neutral

F. Bi-phase Set-up

For the Three-phase No Neutral installation, check compatible EV models that support this configuration.

 The Pulsar Pro three-phase version can be installed with A – B setups.

 Ensure that the maximum voltage is less than 264V between L & N inputs.

9. Closing the Charger

Position the current selector to an appropriate setting. Then, carefully reattach the communication cable to your charger cover and close it.

 Make sure that the selector does not point to 0, 8, or 9.

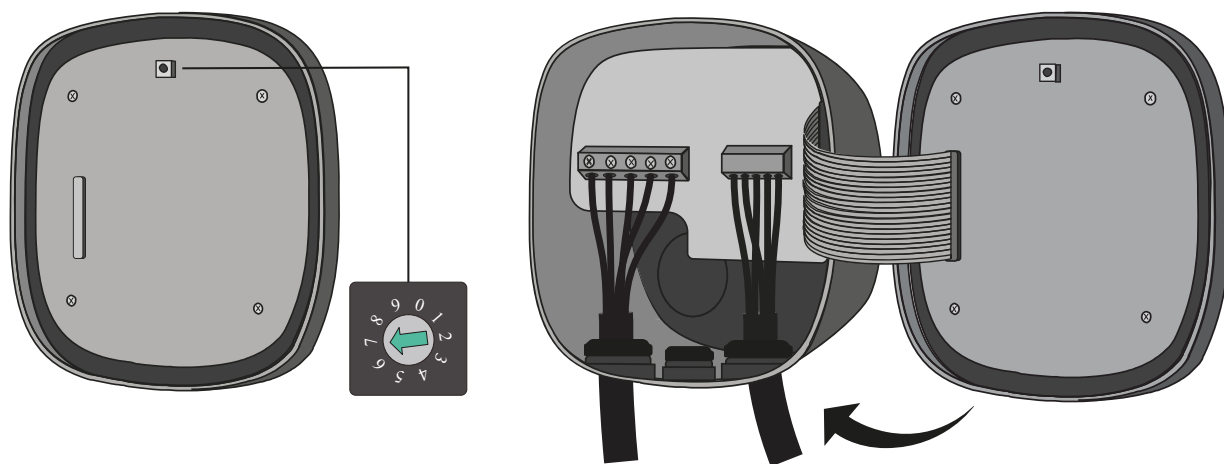

	0	1	2	3	4	5	6	7	8	9
i (A)	-	6	10	13	16	20	25	32	-	-

Insert the four corner screws to secure your charger cover. Make sure to properly align the bottom screw opening, place the cover frame on your charger, and attach the frame with the screw. Do not over-tighten.

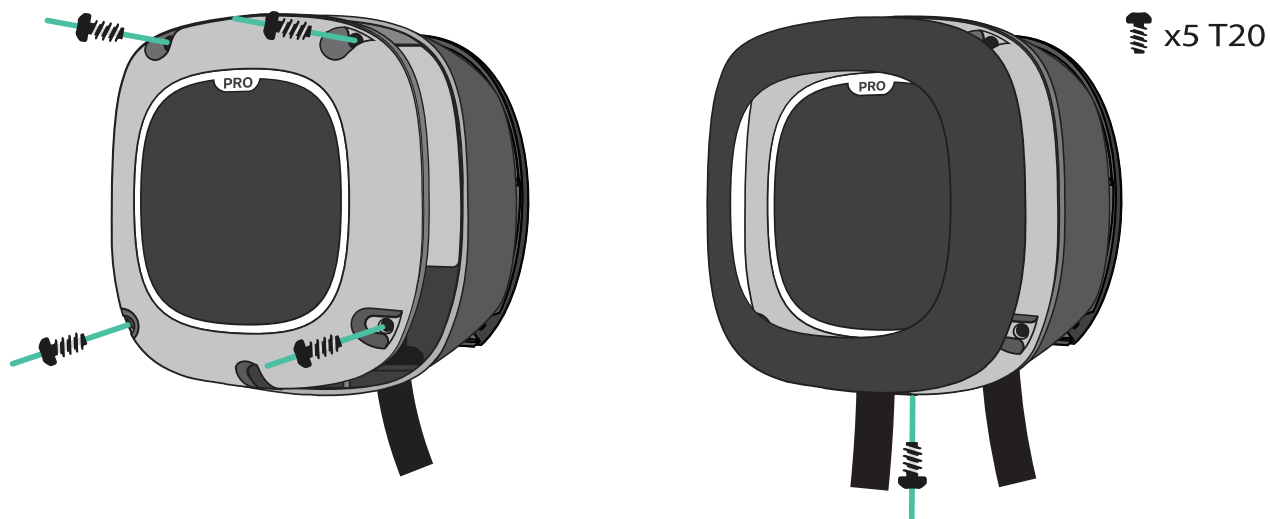

10. Installing the Plug Holder

Place the plug holder on the wall and mark the fixing points. Then, drill holes where the fixing points are marked.

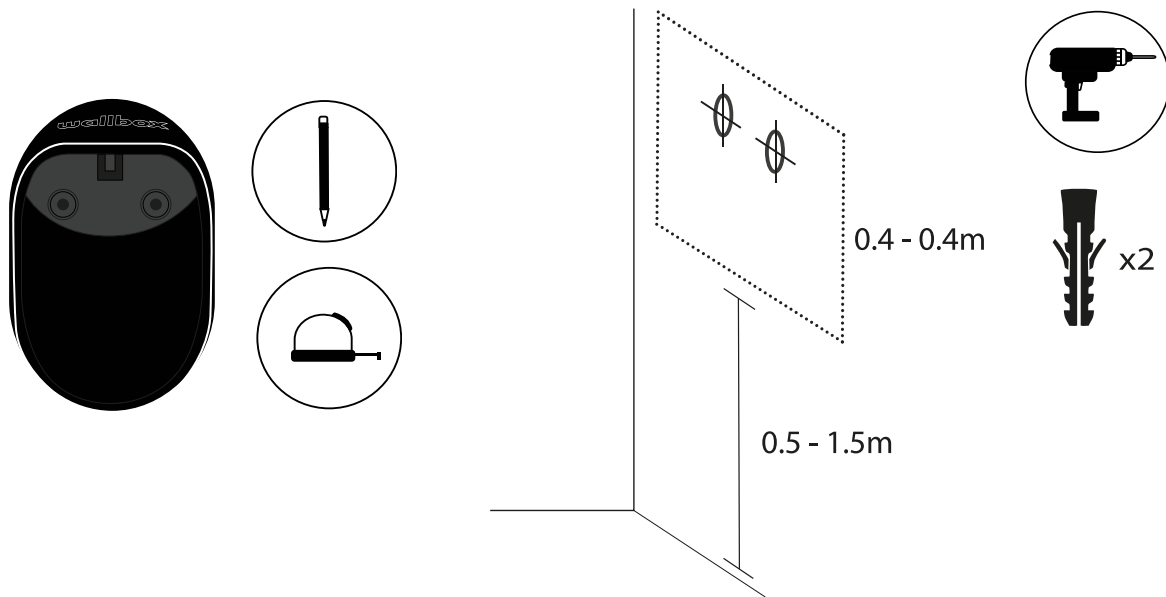

Insert the anchor screws into the fixing holes. Then secure the device to the walls by inserting and tightening the screws.

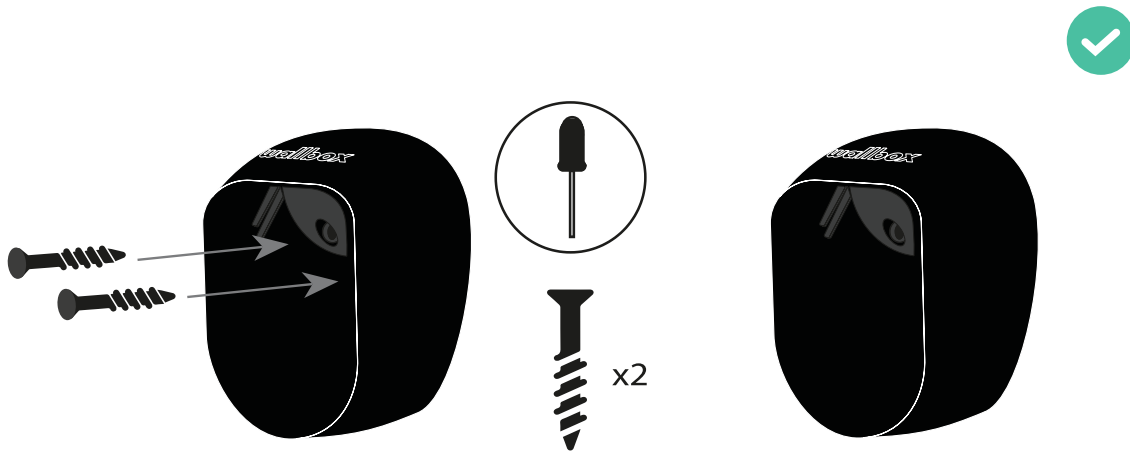

11. Registering the Charger

Download the myWallbox App and register.



